

# Green Laser Diode in TO56 Package

## Version 0.2

---

### PLT5 520B

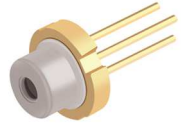

#### Features

- Optical output power (continuous wave): 80 mW ( $T_{\text{case}} = 25\text{ }^{\circ}\text{C}$ )
- Typical emission wavelength: 520 nm
- Efficient radiation source for cw and pulsed operation
- Single transverse mode semiconductor laser
- High modulation bandwidth
- TO56 package with photo diode

#### Applications

- Laser projection
- Laser shows
- Biomedical Applications
- Metrology

#### Safety Advice

Depending on the mode of operation, these devices emit highly concentrated visible light which can be hazardous to the human eye. Products which incorporate these devices have to follow the safety precautions found in IEC 60825-1 "Safety of laser products".



**ATTENTION – Observe Precautions For Handling – Electrostatic Sensitive Device**

**Ordering Information**

Type:	Optical Output Power $P_{\text{opt}} (T_{\text{case}} = 25^{\circ}\text{C})$	Ordering Code
PLT5 520B	80 mW	Q65112A0737

**Maximum Ratings**

Operation outside these conditions may damage the device. Operation at maximum ratings may influence lifetime.

Parameter	Symbol	Values		Unit
		min.	max.	
Operating Current	$I_F$		300	mA
Operating Temperature	$T_{\text{case}}$	-20	+60	$^{\circ}\text{C}$
Storage Temperature	$T_{\text{stg}}$	-40	+85	$^{\circ}\text{C}$
Reverse Voltage	$V_R$		2	V
Soldering Temperature max. 10 sec.	$T_{\text{solder}}$		260	$^{\circ}\text{C}$
Junction temperature	$T_j$		120	$^{\circ}\text{C}$

**Laser Characteristics** ( $T_{\text{case}} = 25^{\circ}\text{C}$ )

Parameter	Symbol	Values			Unit
		min.	typ.	max.	
Emission Wavelength <sup>1)</sup>	$\lambda_{\text{peak}}$	515	520	530	nm
Spectral Width (FWHM) <sup>1)</sup>	$\Delta\lambda$	–	2	–	nm
Threshold Current	$I_{\text{th}}$	–	40	70	mA
Operating Current <sup>1)</sup>	$I_F$	–	200	240	mA
Operating Voltage <sup>1)</sup>	$V_F$	–	6.4	8.0	V
Beam Divergence (FWHM) <sup>1)</sup>	$\theta_1 \times \theta_{\perp}$	5.0 x 18.0	6.3 x 22.5	7.5 x 25.0	deg
Polarization <sup>1)</sup>	$P_{\text{gr}}$	–	100:1	–	
Modulation Frequency	$f$	–	>100	–	MHz
Thermal Resistance (junction to case)	$R_{\text{th}}$	–	34	–	K/W
Monitor Current <sup>1) 2)</sup>	$I_m$	–	110	–	$\mu\text{A}$

<sup>1)</sup> Standard operating conditions refer to a continuous wave output power of  $P_{\text{opt}} = 80$  mW.

<sup>2)</sup> Photo current refers to a reverse voltage of  $V_R = 5$  V.

**Optical Output Power**

$$P_{\text{opt}} = f(I_F)$$

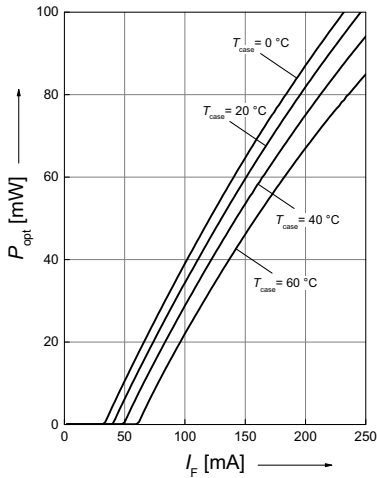
**Operating Voltage**

$$V_F = f(I_F)$$

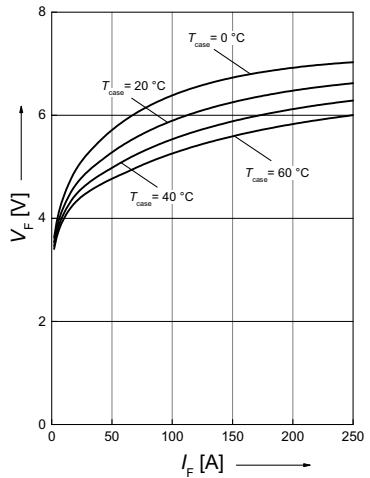
**Threshold Current**

$$I_{\text{th}} = f(T_{\text{case}})$$

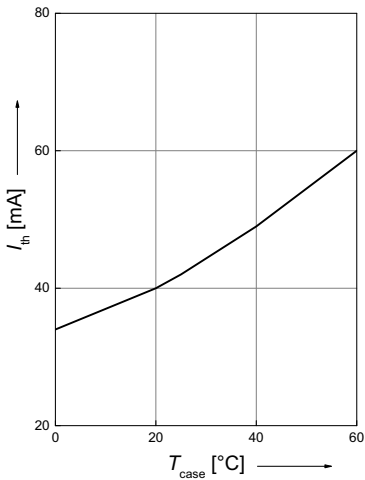
**Relative Spectral Emission**

$$P_{\text{opt}} = f(\lambda)$$

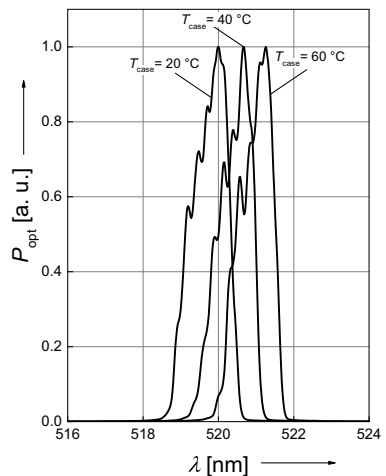

**Beam Divergence**

$$P_{\text{opt}} = f(\theta), T_{\text{case}} = 25\text{ }^{\circ}\text{C}$$

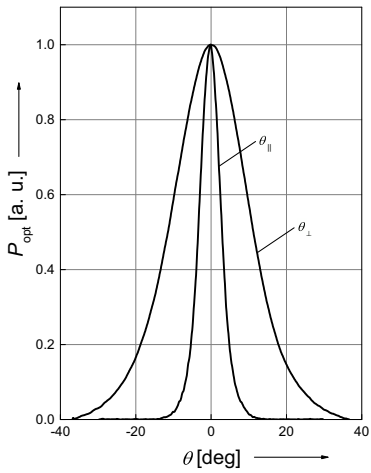
**Maximum recommended operating current**

$$I_F = f(T_{\text{case}})$$

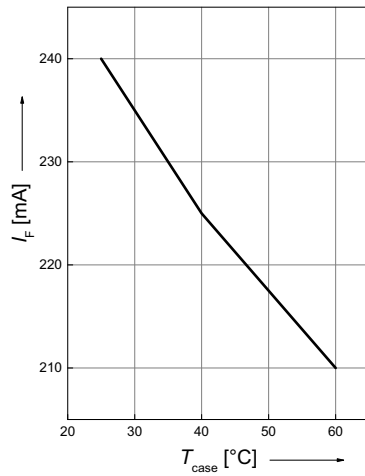

## Package Outline

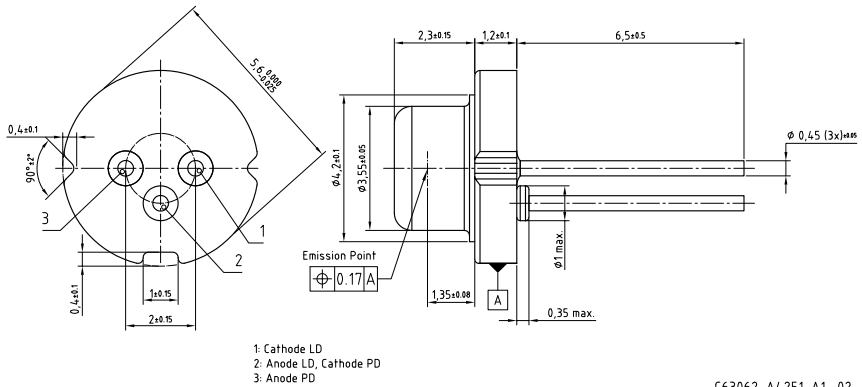

C63062-A4251-A1-02

Dimensions in mm

## Pin Connection

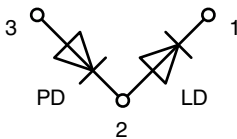

Pin 1: LD Cathode  
 Pin 2: LD Anode, PD Cathode (case)  
 Pin 3: PD Anode

## Disclaimer

OSRAM OS assumes no liability whatsoever for any use of this document or its content by recipient including, but not limited to, for any design in activities based on this preliminary draft version. OSRAM OS may e. g. decide at its sole discretion to stop developing and/or finalizing the underlying design at any time.

### Attention please!

The information describes the type of component and shall not be considered as assured characteristics. Terms of delivery and rights to change design reserved. Due to technical requirements components may contain dangerous substances.

For information on the types in question please contact our Sales Organization.

If printed or downloaded, please find the latest version in the Internet.

### Packing

Please use the recycling operators known to you. We can also help you – get in touch with your nearest sales office. By agreement we will take packing material back, if it is sorted. You must bear the costs of transport. For packing material that is returned to us unsorted or which we are not obliged to accept, we shall have to invoice you for any costs incurred.

### Components used in life-support devices or systems must be expressly authorized for such purpose!

Critical components\* may only be used in life-support devices\*\* or systems with the express written approval of OSRAM OS.

\*) A critical component is a component used in a life-support device or system whose failure can reasonably be expected to cause the failure of that life-support device or system, or to affect its safety or the effectiveness of that device or system.

\*\*) Life support devices or systems are intended (a) to be implanted in the human body, or (b) to support and/or maintain and sustain human life. If they fail, it is reasonable to assume that the health and the life of the user may be endangered.

## Important notes of operation for laser diode

### a) Electrical operation

OSRAMs laser diodes are designed for maximum performance and reliability. Operating the laser diode above the maximum rating even for very short periods of time can damage the laser diode or reduce its lifetime. The laser diode must be operated with a suitable power supply with minimized electrical noise.

The laser diode is very sensitive to electrostatic discharge (ESD). Proper precautions must be taken.

### b) Mounting instructions

In order to maintain the lifetime of the laser diode proper heat management is essential. Due to the design of the laser diode heat is dissipated only through the base plate of the diode's body. A proper heat conducting interconnection between the diodes base plate and the heat sink must be maintained.

Published by OSRAM Opto Semiconductors GmbH  
Leibnizstraße 4, D-93055 Regensburg  
www.osram-os.com © All Rights Reserved.

Eu RoHS compliant product